

MDT 349 L12

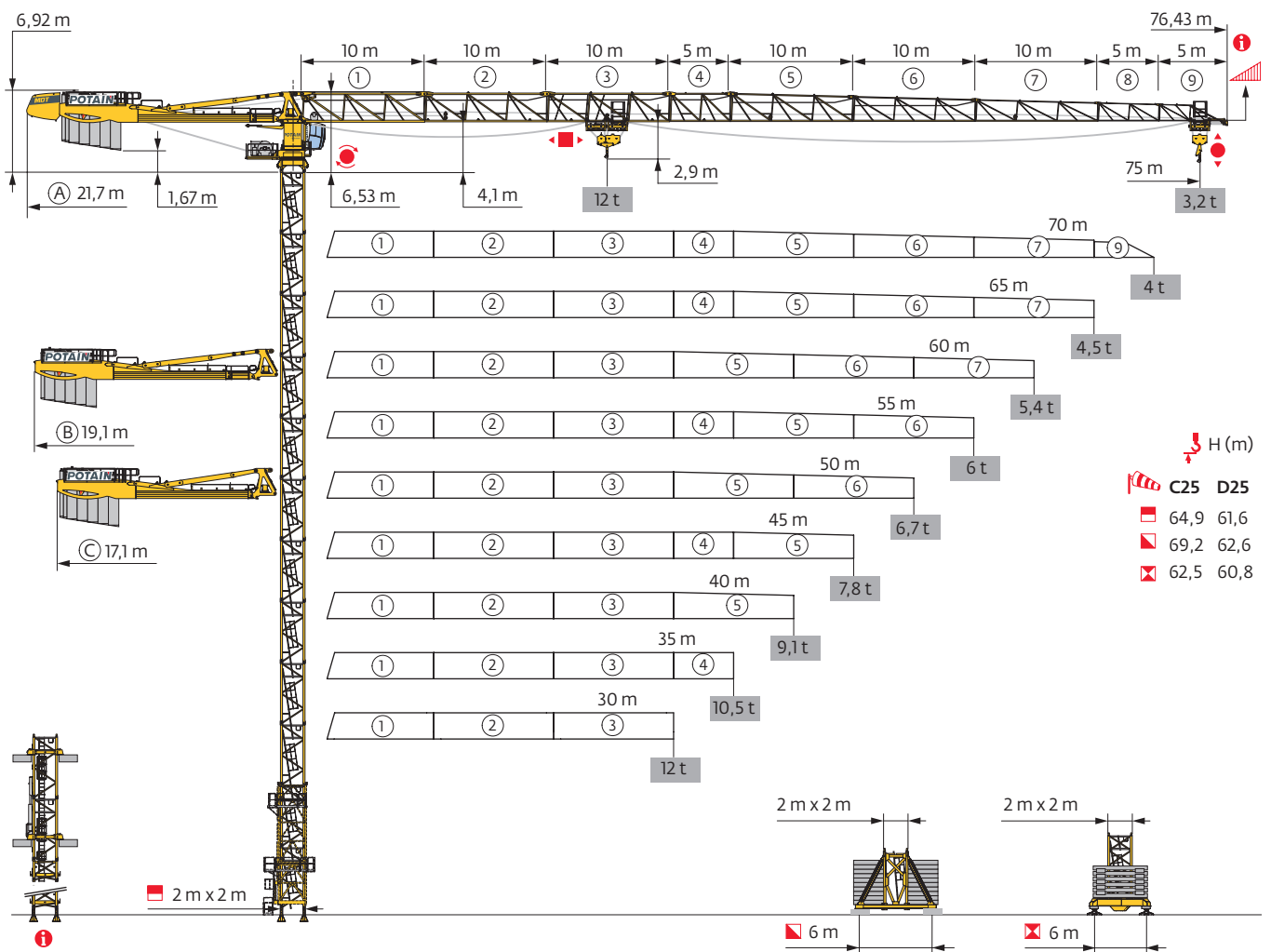

Potain Plus



Power Control

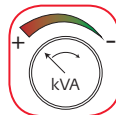

Top Site

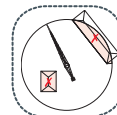

Top Tracing 3

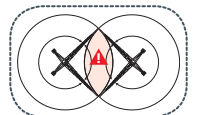

Mât - Réactions / Mast - Reaktionskräfte / Mast - Reactions / Mástil - Reacciones / Torre - Reazioni
 Tramo - Reacções / Реакция опор мачты

□ 2 m - P 62B - C25										
ΔΔΔΔ (m)	30	35	40	45	50	55	60	65	70	75
↕ (m)	64,9	63,2	63,2	63,2	63,2	63,2	63,2	61,6	61,6	61,6
↕/P _r (m)	64,9	63,2	63,2	63,2	63,2	63,2	63,2	61,6	61,6	61,6
⚡	3,33 m	1	2	2	2	2	2	0	0	0
	5 m	12	11	11	11	11	11	12	12	12
F2 (t)	● 190	191	191	187	190	186	186	190	192	190
	■ 266	257	257	254	261	262	265	250	259	266
F3 (t)	● 133	133	132	127	129	125	125	128	131	128
	■ 216	205	204	199	206	207	210	194	203	210
↕ (m) D25	61,6	61,6	61,6	61,6	59,9	59,9	59,9	59,9	58,2	58,2
↕/P _r (m) D25	61,6	61,6	61,6	61,6	59,9	59,9	59,9	59,9	58,2	58,2

□ 2 m - V 60A - V 63A - C25										
ΔΔΔΔ (m)	30	35	40	45	50	55	60	65	70	75
↕ (m)	65,9	65,9	65,9	64,2	64,2	64,2	64,2	60,9	60,9	60,9
↕/P _r (m)	65,9	65,9	65,9	64,2	64,2	64,2	64,2	60,9	60,9	60,9
⚡	3,33 m	0	0	1	1	1	1	0	0	0
	5 m	12	12	12	11	11	11	11	11	11
F1 (t)	● 111	113	114	109	110	108	108	108	109	109
	■ 138	140	140	130	134	134	137	121	126	131
↕ (m) D25	57,5	57,5	57,5	59,2	57,5	57,5	57,5	57,5	55,9	55,9
↕/P _r (m) D25	57,5	57,5	57,5	59,2	57,5	57,5	57,5	57,5	55,9	55,9

□ 2 m - V 63A - V 63A - C25										
ΔΔΔΔ (m)	30	35	40	45	50	55	60	65	70	75
↕ (m)	69,2	69,2	69,2	67,6	67,6	67,6	67,6	65,9	65,9	65,9
↕/P _r (m)	69,2	69,2	69,2	67,6	67,6	67,6	67,6	65,9	65,9	65,9
⚡	3,33 m	1	1	1	2	2	2	0	0	0
	5 m	11	11	11	10	10	10	10	11	11
F1 (t)	● 124	126	124	118	119	121	121	120	124	123
	■ 160	162	161	150	154	155	157	152	158	162
↕ (m) D25	60,9	60,9	60,9	62,6	60,9	60,9	60,9	60,9	60,9	60,9
↕/P _r (m) D25	60,9	60,9	60,9	62,6	60,9	60,9	60,9	60,9	60,9	60,9

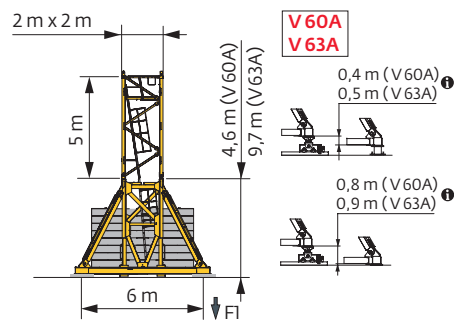
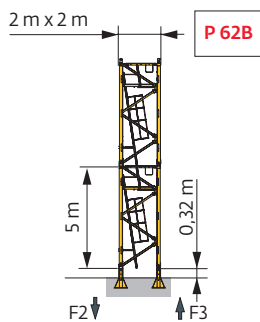

2 m - ZX 6830 - C25

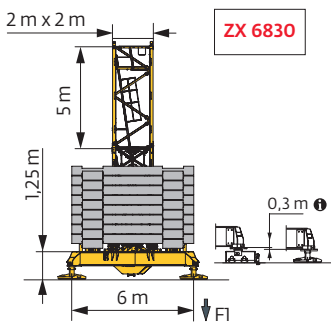

AVAN (m)	30	35	40	45	50	55	60	65	70	75
\downarrow (m)	62,5	62,5	62,5	60,8	62,5	62,5	62,5	59,2	59,2	59,2
\downarrow/P^* (m)	62,5	62,5	62,5	60,8	62,5	62,5	62,5	59,2	59,2	59,2
3,33 m	0	0	0	1	0	0	0	2	2	2
	5 m	12	12	12	11	12	12	12	10	10
Fl (t)	● 106	106	107	102	107	106	106	103	104	103
	■ 117	119	118	109	120	121	123	113	118	123
\downarrow (m) D25	60,8	60,8	60,8	60,8	59,2	59,2	59,2	59,2	57,5	57,5
\downarrow/P^* (m) D25	60,8	60,8	60,8	60,8	59,2	59,2	59,2	59,2	57,5	57,5



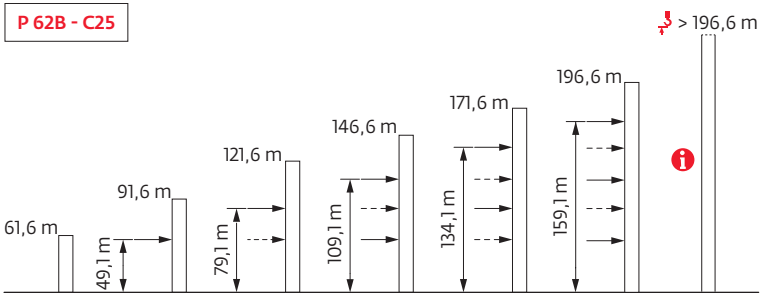





Ancrages / Verankerungen / Anchorages / Anclajes / Ancoraggi
 Ancoragem / нкера



Lest de base / Grundballast / Base ballast / Lastre de base / Zavorra di base
 Lastro da base / Базовый Балласт

 (t) /  2 m - V 60A -  - C25										
h _{max} (m)	30	35	40	45	50	55	60	65	70	75
65,9	120	120	120							
64,2	120	108	108	108	108	108	108			
60,9	108	108	96	96	96	96	96	108	108	108
55,9	96	84	84	84	84	84	84	84	84	84
50,9	72	72	72	72	72	72	60	72	72	72
45,9	60	60	60	60	60	48	48	60	60	60
40,9	60	60	60	48	48	48	48	48	48	60
35,9	60	60	60	48	48	48	48	48	48	60
30,9	60	60	60	48	48	48	48	48	48	60
25,9	60	60	60	48	48	48	48	48	48	60
20,9	60	60	60	48	48	48	48	48	48	60

 (t) /  2 m - V 63A -  - C25										
h _{max} (m)	30	35	40	45	50	55	60	65	70	75
69,2	156	156	144							
67,6	144	144	144	132	132	144	144			
65,9	132	132	120	120	120	120	132	132	144	144
60,9	108	108	108	96	96	96	96	108	108	108
55,9	96	84	84	84	84	84	84	96	84	84
50,9	84	72	72	72	72	72	72	72	72	72
45,9	60	60	60	60	60	60	48	60	60	60
40,9	48	60	60	48	48	48	48	48	60	60
35,9	48	60	60	48	48	48	36	48	48	60
30,9	48	60	60	48	48	48	36	48	48	60
25,9	48	60	60	48	48	48	36	36	48	60
20,9	48	60	60	48	48	48	36	36	48	60

 (t) /  2 m - ZX 6830 -  - C25										
h _{max} (m)	30	35	40	45	50	55	60	65	70	75
62,5	111	101	101		101	101	101			
60,8	101	101	101	91	91	91	91			
59,2	101	91	91	91	91	91	81	91	91	91
54,2	81	81	81	71	71	71	71	81	81	81
49,2	71	71	71	61	61	61	61	61	61	61
44,2	51	61	61	51	51	41	41	51	51	61
39,2	51	61	61	51	51	41	41	41	51	61
34,2	51	61	61	51	51	41	41	41	51	51
29,2	51	61	61	51	51	41	41	41	51	51
24,2	51	61	61	51	51	41	41	41	51	51
19,2	51	61	61	51	51	41	41	41	51	51

Courbes de charges / Lastkurven / Load curves / Curvas de cargas / Curve di carico / Curvas de carga / Кривые нагрузок



↕ (m)		22	27	30	32	35	37	40	42	45	47	50	52	55	57	60	62	65	67	70	72	75	m	
↕	↕ 12 t	↕											↕											
↕	↕ ↕ 6 t	↕											↕											
75	3,1 → 22,4	39,8 - 43,3	12	9,6	8,5	7,9	7,1	6,6	6	6	5,7	5,4	5,1	4,8	4,5	4,3	4	3,8	3,6	3,4	3,2	3,1	2,85	t
	3,1 → 23	40,8 - 44,4	12	9,9	8,8	8,1	7,3	6,8	6,2	6	5,9	5,6	5,2	5	4,7	4,5	4,2	4	3,8	3,7	3,5	3,3	3,2	t P+
70	3,1 → 24	42,7 - 46,2	12	10,4	9,2	8,5	7,7	7,2	6,5	6,1	6	5,9	5,5	5,2	4,8	4,6	4,3	4,1	3,9	3,7	3,5	t		
	3,1 → 25,6	45,5 - 49,3	12	11,2	9,9	9,2	8,3	7,7	7	6,6	6,1	6	5,9	5,6	5,3	5,1	4,8	4,6	4,3	4,2	4	t	P+	
65	3,1 → 25,4	45,5 - 49,2	12	11,2	9,9	9,2	8,2	7,7	7	6,6	6,1	6	5,9	5,6	5,2	5	4,6	4,4	4,1	t				
	3,1 → 26,8	48,1 - 52	12	11,9	10,5	9,8	8,8	8,3	7,5	7,1	6,5	6,2	6	6	5,6	5,4	5	4,8	4,5	t	P+			
60	3,1 → 26,8	48,3 - 52,1	12	11,9	10,5	9,8	8,8	8,3	7,5	7,1	6,5	6,2	6	6	5,6	5,4	5,1	t						
	3,1 → 28,1	50,8 - 55	12	12	11,2	10,4	9,3	8,8	8	7,5	6,9	6,6	6,1	6	6	5,7	5,4	t	P+					
55	3,1 → 27,5	49,6 - 53,4	12	12	10,9	10,1	9,1	8,5	7,8	7,3	6,7	6,4	6	6	5,8	t								
	3,1 → 29,1	52,6 - 55	12	12	11,6	10,8	9,7	9,1	8,3	7,9	7,2	6,9	6,4	6,1	6	t	P+							
50	3,1 → 28,7		12	12	11,4	10,6	9,6	9	8,2	7,8	7,2	6,8	6,3	t										
	3,1 → 30,1		12	12	12	11,2	10,1	9,5	8,7	8,2	7,5	7,2	6,6	t	P+									
45	3,1 → 29,4		12	12	11,7	10,9	9,8	9,2	8,4	8	7,3	t												
	3,1 → 30,8		12	12	12	11,5	10,4	9,7	8,9	8,4	7,7	t	P+											
40	3,1 → 29,8		12	12	11,9	11	10	9,4	8,5	t														
	3,1 → 31,2		12	12	12	11,7	10,5	9,9	9	t	P+													
35	3,1 → 29,6		12	12	11,8	11	9,9	t																
	3,1 → 31		12	12	12	11,6	10,4	t	P+															
30	3,1 → 29,9		12	12	11,9	t																		
	3,1 → 29,9		12	12	11,9	t	P+																	

↕ = ↕ - 0,61 t max.



↕ (m)		22	27	30	32	35	37	40	42	45	47	50	52	55	57	60	62	65	67	70	72	75	m	
↕	↕ 12 t	↕											↕											
↕	↕ ↕ 6 t	↕											↕											
75	2,4 → 22,5	40,2 - 41,1	12	9,7	8,6	7,9	7,1	6,6	6	5,8	5,4	5,1	4,7	4,5	4,1	3,9	3,6	3,5	3,2	3,1	2,85	2,7	2,5	t
	2,4 → 23,1	41,2 - 42,1	12	10	8,8	8,2	7,3	6,8	6,2	6	5,5	5,2	4,8	4,6	4,3	4,1	3,8	3,7	3,4	3,3	3,1	2,95	2,8	t P+
70	2,4 → 24	43 - 44	12	10,5	9,3	8,6	7,7	7,2	6,6	6,2	5,8	5,5	5,1	4,9	4,5	4,3	4	3,8	3,5	3,3	3,1	t		
	2,4 → 25,6	45,8 - 47	12	11,3	10	9,3	8,3	7,8	7,1	6,7	6,1	6	5,5	5,3	4,9	4,7	4,4	4,2	4	3,8	3,6	t	P+	
65	2,4 → 25,5	45,8 - 47	12	11,2	9,9	9,2	8,3	7,8	7,1	6,7	6,1	6	5,5	5,3	4,9	4,6	4,3	4,1	3,8	t				
	2,4 → 27	48,5 - 49,6	12	12	10,6	9,8	8,9	8,3	7,6	7,1	6,6	6,2	5,9	5,7	5,3	5	4,7	4,5	4,2	t	P+			
60	2,4 → 27	48,7 - 50	12	12	10,6	9,9	8,9	8,3	7,6	7,2	6,6	6,3	6	5,7	5,3	5,1	4,8	t						
	2,4 → 28,3	51,2 - 52,4	12	12	11,2	10,4	9,4	8,8	8,1	7,6	7	6,7	6,2	6	5,7	5,4	5,1	t	P+					
55	2,4 → 27,6	50 - 51,1	12	12	10,9	10,1	9,1	8,6	7,8	7,4	6,8	6,5	6	5,9	5,5	t								
	2,4 → 29,2	53 - 54,2	12	12	11,7	10,8	9,8	9,2	8,4	7,9	7,3	6,9	6,4	6,1	5,9	t	P+							
50	2,4 → 28,9		12	12	11,5	10,7	9,7	9,1	8,3	7,8	7,2	6,9	6,4	t										
	2,4 → 30,2		12	12	12	11,2	10,2	9,5	8,7	8,2	7,6	7,2	6,7	t	P+									
45	2,4 → 29,6		12	12	11,8	11	9,9	9,3	8,5	8	7,4	t												
	2,4 → 31		12	12	12	11,5	10,4	9,8	8,9	8,5	7,8	t	P+											
40	2,4 → 30		12	12	12	11,1	10	9,4	8,6	t														
	2,4 → 31,4		12	12	12	11,7	10,6	10	9,1	t	P+													
35	2,4 → 29,8		12	12	11,9	11,1	10	t																
	2,4 → 31,1		12	12	12	11,6	10,5	t	P+															
30	2,4 → 30		12	12	12	t																		
	2,4 → 30		12	12	12	t	P+																	

↕ = ↕ - 0,17 t max.

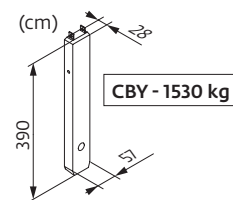
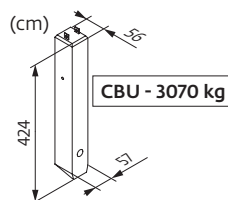
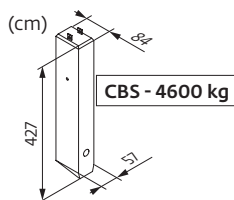

Poids de flèche & lest de contre-flèche / Auslegergewicht & Gegenauslegerballast / Jib weight & counter-jib ballast / Peso de flecha y lastre de contra-flecha/Peso del braccio & zavorra di contro-braccio/Peso da lança & lastro da contra lança/Вес стрелы и балласт контр-стрелы

↕	↕ (kg) (+/- 5%)			↕		↕ (kg)	↕		
	↕ ↕	↕	↕ ↕	4600 kg	1530 kg		3070 kg	1530 kg	↕ (kg)
75 m	17830	17455	17890	5	2	26060	8	1	26090
70 m	17570	17210	17620	5	2	26060	8	1	26090
65 m	17180	16850	17235	5	2	26060	8	1	26090
60 m	16150	15850	16210	5	1	24530	8	0	24560
55 m	16150	15850	16210	5	1	24530	8	0	24560
50 m	15200	14900	15260	5	2	26060	8	1	26090
45 m	15050	14750	15110	5	2	26060	8	1	26090
40 m	14220	13920	14280	5	0	23000	7	1	23020
35 m	13610	13310	13670	4	2	21460	7	0	21490
30 m	12780	12480	12840	4	1	19930	6	1	19950











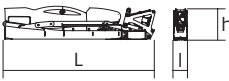
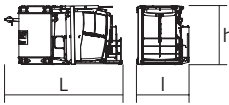
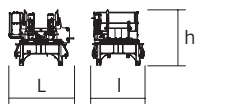
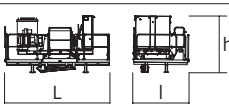
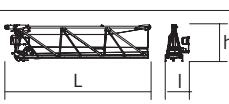
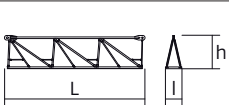

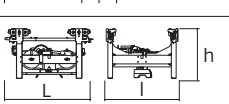

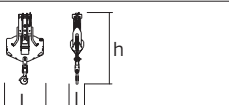

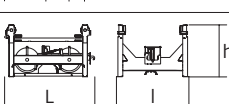
Encombrenment et poids / Abmessungen und Gewicht / Dimensions and weight / Dimensiones y peso / Ingombro e peso
 dimensões e pesos / габаритные размеры и вес

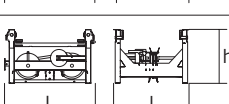
Partie tournante / Drehender Kranteil / Slewing crane part / Parte giratoria

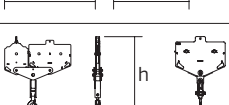
Parte rotante / Parte rotativa / Поворотная часть :  75 m -  -  75 HPL™

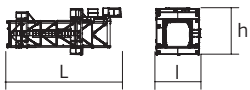
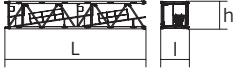

Partie tournante / Drehender Kranteil / Slewing crane part Parte giratoria / Parte rotante / Parte rotativa Поворотная часть		L (m)	l (m)	h (m)	kg (+/- 5%)	
Contre-flèche / Gegenausleger Counter-jib / Contra-flecha Controbraccio / Contra-lança Контр-стрела		A 12 B 12 C 12		1,25 2,5 1,25 2,5	14110 13600 11540	
Mât-cabine + cabine / Kabinenmast + Kabine Cab mast + cab / Mástil-cabina + cabina Portaralla superiore + cabina / Tramo-cabina + cabina Секция мачты кабины + кабина		Ultra View	5,03	2,22	2,49	6720
Pivot / Krankopf Towerhead / Pivote Portaralla / Pivot Секция поворотной части		∇ 2 m	2,95	2,48	2,5	7620
Treuil de levage (+ câble) / Hubwerk (+ Seil) Hoisting winch (+ rope) / Mecanismo de elevación (+ cabo) Argano di sollevamento (+ fune) Guincho de elevação (+ cabo) Подъемная лебедка (+ канатом)		75 HPL™ 100 LVF	4,27 4,27	2,3 2,3	2,32 2,32	4500 4950
Elément de flèche / Auslegerement Jib section / Elemento de flecha Elemento di braccio / Elemento de lança Секция стрелы		① 6 DVF	10,75	1,8	2,74	5500
Elément de flèche / Auslegerement Jib section / Elemento de flecha Elemento di braccio / Elemento de lança Секция стрелы		② ③ ⑤ ⑥ ⑦	10,21 10,31 10,22 10,24 10,19	1,2 1,2 1,2 1,2 1,2	2,5 2,42 2,39 2,1 1,83	3145 2420 1560 1235 950
Elément de flèche / Auslegerement Jib section / Elemento de flecha Elemento di braccio / Elemento de lança Секция стрелы		④ ⑧ ⑨	5,27 5,09 5,09	1,2 1,2 1,2	2,39 1,53 1,39	960 310 220
Chariot / Laufkatze Trolley / Carrello Carro / Carro-distribuidor Тележка		 12 t	1,87	1,51	1,05	400
Moufle / Hubflasche Pulley block / Aparejo Bozzello / Cadernal Полиспаст		 12 t	1,19	0,43	2,31	455
Chariot / Laufkatze Trolley / Carrello Carro / Carro-distribuidor Тележка		 12 t	1,57	1,51	0,98	210
Chariot / Laufkatze Trolley / Carrello Carro / Carro-distribuidor тележка		 12 t  6 t	1,7 1,86	1,51 1,51	1,03 0,98	245 236
Moufle / Hubflasche Pulley block / Aparejo Bozzello / Cadernal Полиспаст		 12 t  6 t	1,65 1,09	0,22 0,27	1,78 1,62	450 265

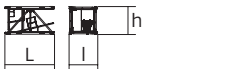
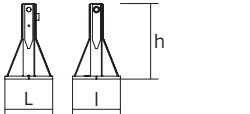
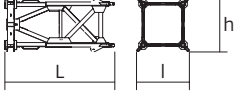
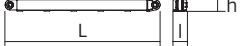
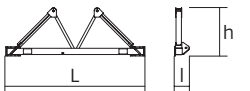
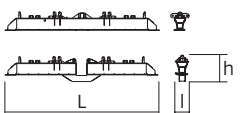
Рылёне / Kranturm / Crane tower Mástil / Torre / Torre Башня крана		L (m)	l (m)	h (m)	kg (+/- 5%)	
T 61		10,83	4,14	4,47	9700	
K 649B KM 649E		10,23 10,29	2,07 2,03	2,03 2,03	5290 4850	
K 649A KMT 649A KR 649A KRMT 649A		5,23 5,23 5,23 5,23	2,07 2,07 2,1 2,1	2,03 2,03 2,08 2,08	2805 2570 3250 3050	
K 649C KRMT 649C		3,57 3,57	2,07 2,1	2,03 2,08	1985 2450	
Pieds de scellement / VerankerungsfüÙe Fixing angles / Pie de empotramiento Montante da annegare / Angulos fixadores анкера		P 62B	0,65	0,65	1,27	295
Mât-châssis / Grundmasteinheit Basic mast unit / Tramo-chasis Elemento base / Tramo-chassis Мачта для крепления к шасси		V 60A V 63A	5,01 10,02	2,41 2,41	2,41 2,41	4390 7485
Haubans / Mastabstüzungen / Struts / Tornapuntas Puntoni / Escoras / Растяжка		V 60A V 63A	4,51 4,51	0,29 0,33	0,29 0,33	420 515
Sommier / Unterwagenhälfte Half-bearer / Testero Testata / Estrutura base Траверса		V 60A V 63A	6,7 6,7	0,7 0,7	2,31 2,31	1600 1850
Bras de crois / Fundamentkreuzträger Cross girder / Braço en cruz / Braccio croce / Braço da cruz Поперечная балка		ZX 6830	9,1 9,1	1,12 0,76	1,1 1,48	5265 5445

Mécanismes / Triebwerke / Mechanisms / Mecanismos / Meccanismi
 Mecanismos / Механизмы

400 V - 50 Hz												ch - PS	kW			
	75 HPL™ 30	m/min	44	57	81	137	220	23	30	43	77	110	75	55	845 m	
	100 LVF 30 Optima	m/min	61,5	79	105,5	136,5	162,5	32	41,5	55	71,5	81,5	100	75	941 m	
	6 DVF 6 Optima	m/min	0 → 42 (12 t) 0 → 84 (8 t) 0 → 100 (4 t)											5,5	4	
	RVF 172 Optima+	tr/min U/min rpm	0 → 0,8											2 x 10	2 x 7,5	

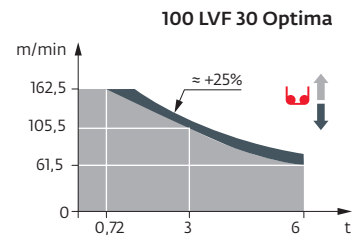

400 V (+10% -10%) 50 Hz	75 HPL™ : 84 → 54 kVA 100 LVF : 104 → 64 kVA

	FR	DE	EN	ES	IT	PT	RU
	Profil de vent suivant EN 14439 C25-D25	Windbedingungen gemäss EN 14439 C25-D25	Wind conditions according to EN 14439 C25-D25	Conformidad de los condiciones de viento EN 14439 C25-D25	Condizioni del vento secondo EN 14439 C25-D25	Perfil de vento conforme EN 14439 C25-D25	Ветровой режим в соответствии с EN 14439 C25-D25
	Appel de flèche	Auslegerüberhöhung	Jib elevation	Elevación de la flecha	Inclinazione braccio	Desvio da lança	подъем стрелы
	Équipements standards	Standardausrüstungen	Standard equipment	Equipamiento de serie	Equipaggiamento standard	Equipamento de série	Стандартное оборудование
	Équipements optionnels	Sonderausrüstungen	Options	Equipamiento opcional	Equipaggiamento in opzione	Equipamento opcional	Дополнительное оборудование (опция)
	Fonction Potain Plus : Courbes de charges Plus	Funktion Potain Plus: Plus-Lastkurven	Potain Plus function: Plus load curves	Función Potain Plus: Diagrama de cargas Plus	Funzione Potain Plus: Curve di carico Plus	Função Potain Plus: Diagrama de cargas Plus	Функция контроля мощности Potain Plus: Диаграммы грузоподъемности Plus
	Hauteurs sous crochet associées aux courbes de charges Plus	Hakenhöhen mit Plus-Lastkurven	Hook heights with Plus load curves	Altura bajo gancho, usando el diagrama de cargas Plus	Altezze sotto gancio con curve di carico Plus	Altura livre, utilizando o diagrama de cargas Plus	Высота под крюком для диаграмм грузоподъемности Plus
	Réactions en service	Reaktionskräfte in Betrieb	Reactions in service	Reacciones en servicio	Reazioni in servizio	Reações em serviço	Реакция при работе
	Réactions hors service	Reaktionskräfte außer Betrieb	Reactions out of service	Reacciones fuera de servicio	Reazioni fuori servizio	Reações fora de serviço	Реакция в покое
	Poids total du lest	Ballast-Gesamtgewicht	Total ballast weight	Peso total del lastre	Peso totale della zavorra	Peso total do lastro	Общий вес балласта
	Cadre d'ancrage serré	Fester Verankerungsrahmen	Tightened anchorage frame	Marco de anclaje de apriete	Quadro di ancoraggio stretto	Quadro de amarração apertado	Объединенная анкерная рама
	Cadre d'ancrage desserré	Looser Verankerungsrahmen	Loosened anchorage frame	Marco de anclaje de desapriete	Quadro di ancoraggio allentato	Quadro de amarração solto	Отсоединенная анкерная рама
	Poids de flèche	Auslegergewicht	Jib weight	Peso de flecha	Peso del braccio	Peso da lança	вес стрелы
	Camion 13,4 m	Lkw 13,4 m	Lorry 13,4 m	Camión 13,4 m	Camion 13,4 m	Camião 13,4 m	Ррузовой автомобиль 13,4 м
	Conteneur High Cube 40', et/ou Flat Rack 20'	Container High Cube 40', und/oder Flat Rack 20'	Container High Cube 40', and/or Flat Rack 20'	Contenedor High Cube 40', y/o Flat Rack 20'	Container High Cube 40', e/o Flat Rack 20'	Contentor High Cube 40', e/ou Flat Rack 20'	40-футовый контейнер повышенной вместимости High Cube, и/или 20-футовая открытая платформа Flat Rack
	Levage	Heben	Hoisting	Elevación	Sollevamento	Elevação	Подъем
	Distribution	Katzfahren	Trolleying	Distribución	Distribuzione	Distribuição	Перемещение по стреле
	Orientation	Schwenken	Slewing	Orientación	Rotazione	Rotação	Поворот
	Translation	Kranfahren	Travelling	Traslación	Traslazione	Translação	Перемещение крана
	Puissance requise	Erforderliche Leistung	Required power	Potencia Necesaria	Potenza richiesta	Potência Necessária	Потребляемая мощность
	Fonction Power Control : vitesses treuils adaptés à la puissance disponible	Funktion Power Control: Geschwindigkeiten der Triebwerke werden an die verfügbare Leistung angepasst	Power Control Function: winch speeds adapted to the available power	Función Power Control: marchas de los cabrestantes adaptadas a la potencia disponible	Funzione Power Control: velocità degli argani adattate alla potenza disponibile	Função Power Control: velocidades de guincho adaptadas à potência disponível	Функция контроля мощности Power Control: регулировка скорости лебедок в зависимости от доступной мощности
	Nous consulter	Auf Anfrage	Consult us	Consultarnos	Consultateci	Consultar-nos	Проконсультируйтесь у нас
	Document commercial non contractuel. Pour toute information technique se référer à la notice correspondante.	Unverbindliches Vertriebsdokument. Für technische Informationen, siehe die entsprechenden Anweisungen.	This commercial document is not legally binding. For any technical information, please refer to the corresponding instructions.	Documento comercial no contractual. Para cualquier información técnica, ver la noticia correspondiente.	Documento commerciale non vincolante, per tutte le informazioni tecniche fare riferimento al catalogo istruzioni.	Documento comercial não contratual. Para qualquer informação técnica complementar consultar as respectivas instruções.	Этот коммерческий документ не является юридически обязательным. Для получения технической информации, см. соответствующие инструкции.

